

A | B | C | D | E | F

PAPER SIZE	DRAWING NUMBER	
B SIZE	GD-J8645	
REV	REVISION DATE	ECO
A	08-31-09	9624

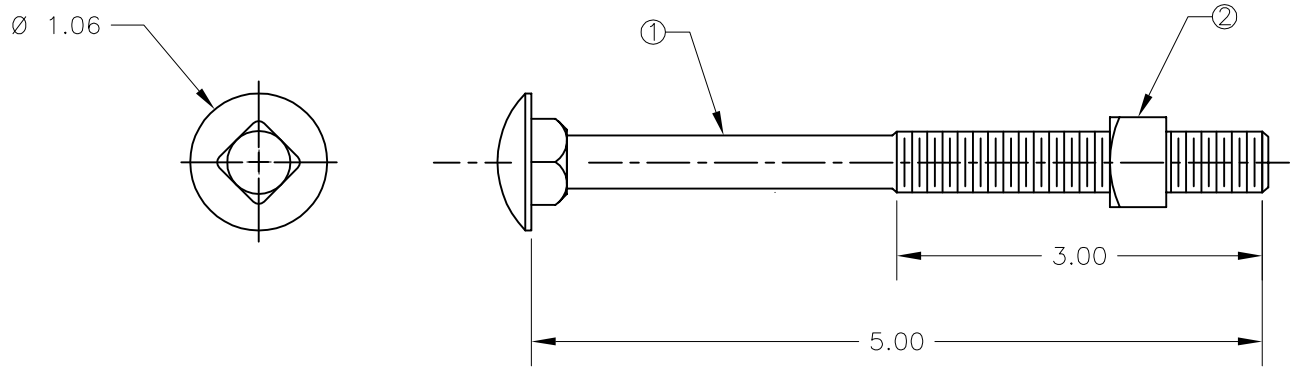

ITEM	QUANTITY	DESCRIPTION
1	1	.500 CARRIAGE BOLT
2	1	.500 REGULAR SQUARE NUT

NOTES:
 1) ALL DIMENSIONS ARE REFERENCE AND IN INCHES.
 2) ALL COMPONENTS HOT DIP GALVANIZED.

CATALOG NUMBER J8645

This drawing contains confidential information that is the property of MacLean Power, L.L.C. ("MacLean"). Use of MacLean's confidential information without MacLean's express written consent is strictly prohibited and may expose you to legal liability. If you believe that you received this material in error, please destroy it or return it to "MacLean Power, L.L.C., 11411 Addison, Franklin Park, Illinois 60131, USA."

F102287

DRAWING-COMPUTER LOCATION:
 DRAWING-COMPUTER LOCATION:

TOLERANCES UNLESS SPECIFIED	INCH
0.XX	— — —
0.XXX	— — —
ANGLE	— — —



DRAWN BY	ENGINEER	CHECKER	CATALOG #	SCALE	DESIGN DATE
RC	RRL	FJS	J8645	---	08-31-09
DRAWING TITLE / DESCRIPTION					DRAWING NUMBER
BOLT CARRIAGE 1/2"					GD-J8645