

THREE PHASE INSTALLATION LAYOUT

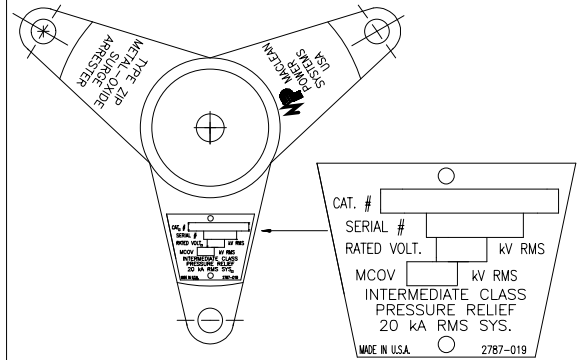

TRIPOD BASE AND NAMEPLATE

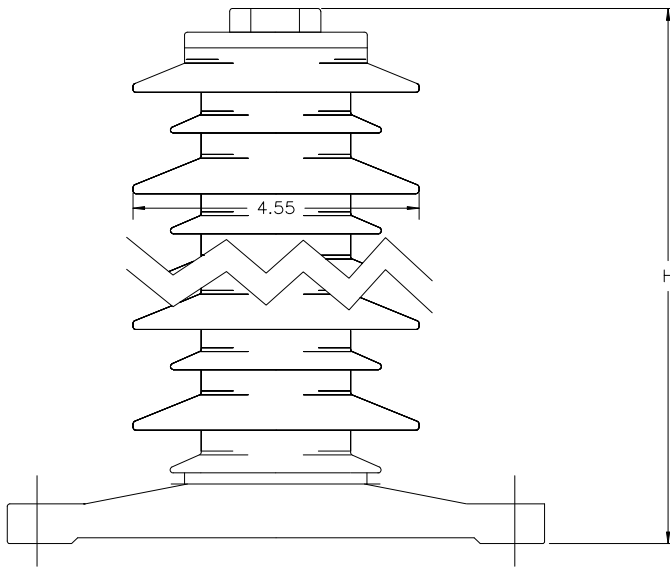

PHYSICAL CHARACTERISTICS

HEIGHT IN./(MM)	CREEP IN./(MM)	WEIGHT LBS./(kg)
15.9/(403)	40.3/(1024)	15.7/(7.1)

Min. Clearance - in./(mm)		Pressure Relief
A	R	
10.5/(267)	8.8/(224)	20 kA

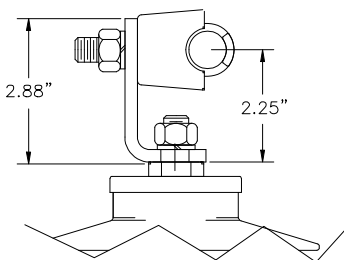

TOP TERMINAL OPTION 1
USED ON -1111, -1131

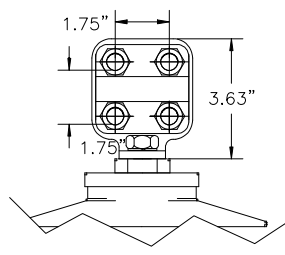

TOP TERMINAL OPTION 2
USED ON -1211, -1231

ELECTRICAL CHARACTERISTICS

RATING kV-RMS	MCOV kV-RMS	F.O.W. kV-CREST	MAX SWITCH. kV-CREST
33	26.7	91.9	68.2

MAX DISCHARGE VOLTAGE (kV-CREST)

1.5 kA	3 kA	5 kA	10 kA	20 kA	40 kA
72.9	77.0	80.6	86.9	96.3	108.0

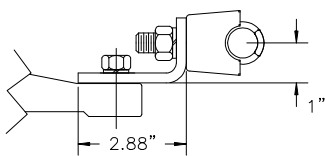

BOTTOM TERMINAL OPTION 1
USED ON -1111, -1211

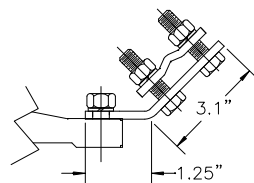

BOTTOM TERMINAL OPTION 3
USED ON -1231, -1131



MACLEAN POWER SYSTEMS

www.maclepower.com

POLYMER HOUSED GAPLESS METAL OXIDE
ZJP INTERMEDIATE CLASS ARRESTER
33 KV RATED, 26.7 KV MCOV
PRESSURE RELIEF 20 KA

THIS DRAWING IS THE PROPERTY OF MACLEAN POWER SYSTEMS AND EMBODIES A CONFIDENTIAL PROPRIETARY DESIGN IN WHICH MACLEAN POWER SYSTEMS RETAINS ALL PATENTS AND PROPRIETARY RIGHTS, INCLUDING EXCLUSIVE RIGHT OF USE, MANUFACTURE AND SALE. BY ACCEPTING THIS DRAWING, THE RECIPIENT AGREES NOT TO DISCLOSE, REPRODUCE OR USE ANY INFORMATION CONTAINED HEREIN WITHOUT THE PRIOR WRITTEN CONSENT OF MACLEAN POWER SYSTEMS.

DATE	07/20/07
DRAWN	SPH
CHECKED	

ZJP0033-1XX1

DO NOT SCALE DRAWING SHEET OF